

# Alphabet Pack

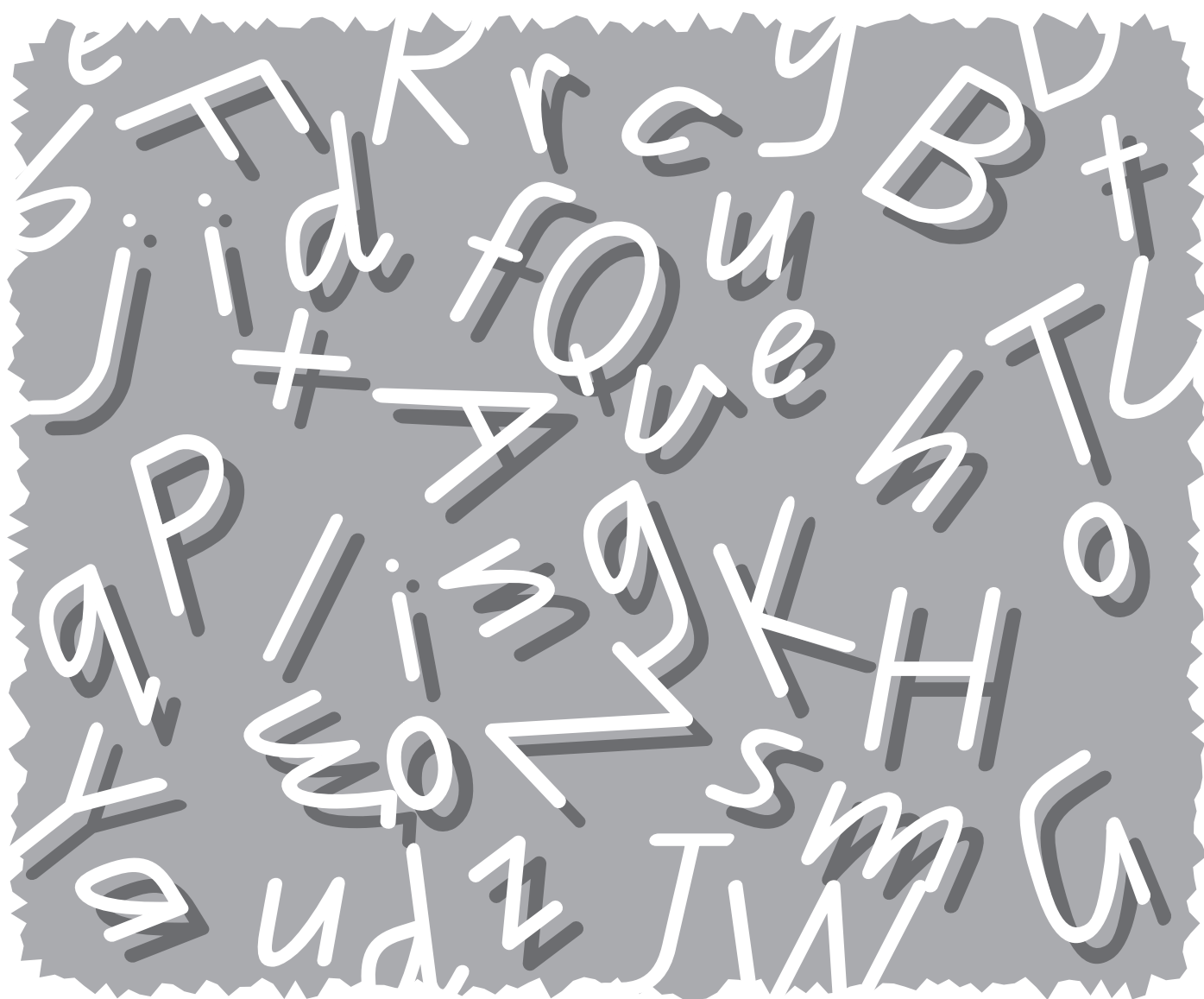

Year 1

---

© THE STATE OF QUEENSLAND (DEPARTMENT OF EDUCATION) 1995



**Produced by:**  
**Open Access Unit**  
**Gabba Towers**  
**411 Vulture Street**  
**Woolloongabba Q 4102**

Open Access Unit  
Teaching and Learning Branch  
Education Services Directorate  
Education Queensland

Print No: 19980752

Copyright protects this publication. Except for purposes permitted by the Copyright Act, reproduction by whatever means is prohibited. However, limited photocopying for classroom use is permitted by educational institutions that have a licence with the Copyright Agency Limited (CAL).

Every reasonable effort has been made to obtain permission to use copyright material. We would be pleased to hear from any copyright holder who has been omitted or incorrectly acknowledged.



## **Alphabet Book**

Keep handy for easy reference.

# Introduction

## General information

The Alphabet Book is designed to provide information and activities about the letters of the alphabet. For each letter of the alphabet the book contains:

- letter modelling and handwriting directions (providing guidelines for letter formation) These pages are used in the introduction of letters in Session 1 of the LAC program.
- a practice page (providing space to practise handwriting patterns and modelled letters) These pages may be completed on Day 10 or in spare time.

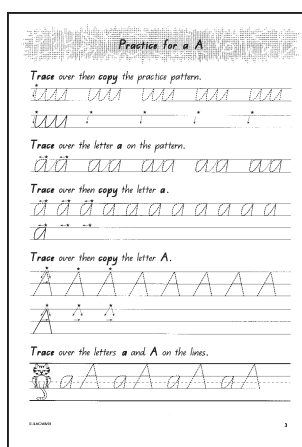
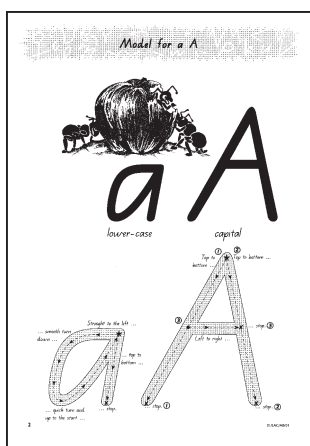

- a letter activity page (focusing on letter recognition and phonics) These pages are used in revision activities in Session 1.
- a word list and alphabet jingle (focusing on words beginning with the letter) These pages are used in revision activities for letters and sounds, but can be added to at any time as words of interest arise.

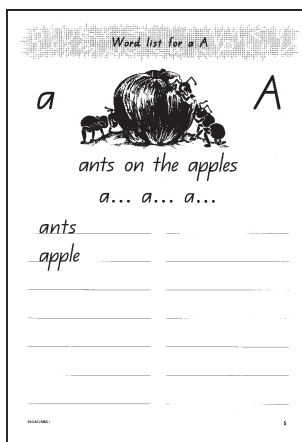
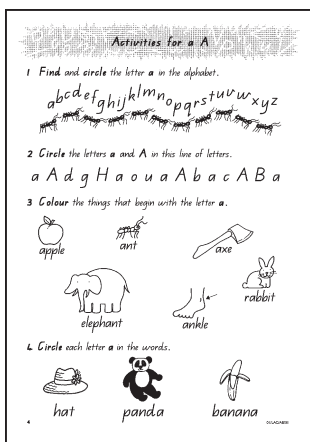

**Note**  
Keep the Alphabet Book handy for you and your child to refer to at any time.



# Model for a A



lower-case



capital

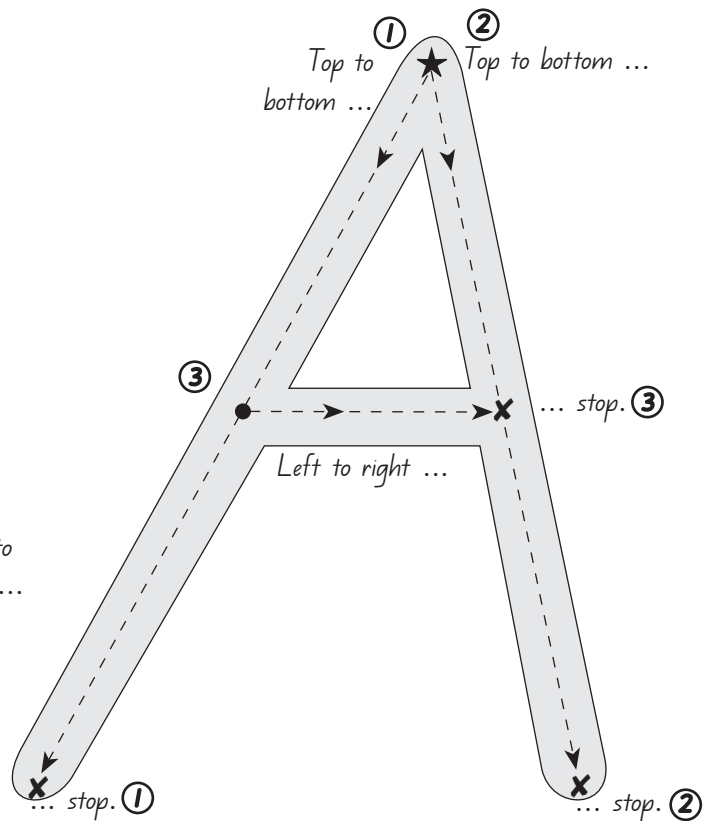
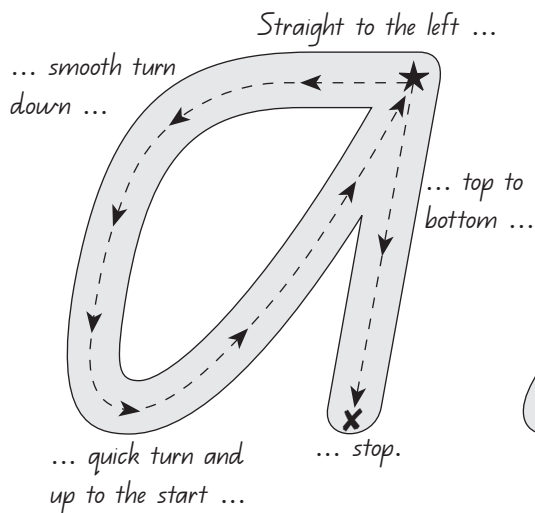

# Practice for a A

Trace over then **copy** the practice pattern.

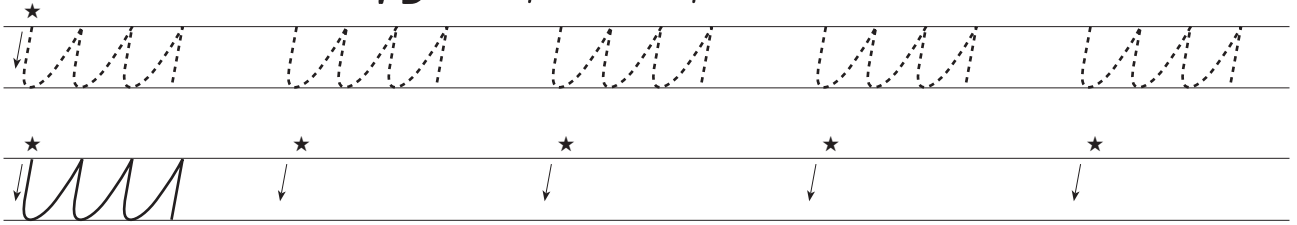

Trace over the letter **a** on the pattern.

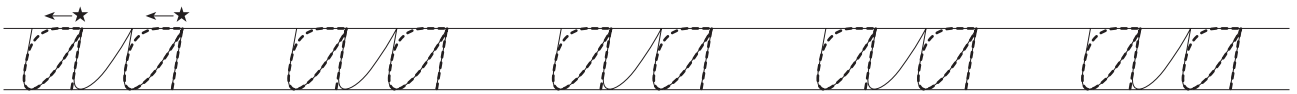

Trace over then **copy** the letter **a**.

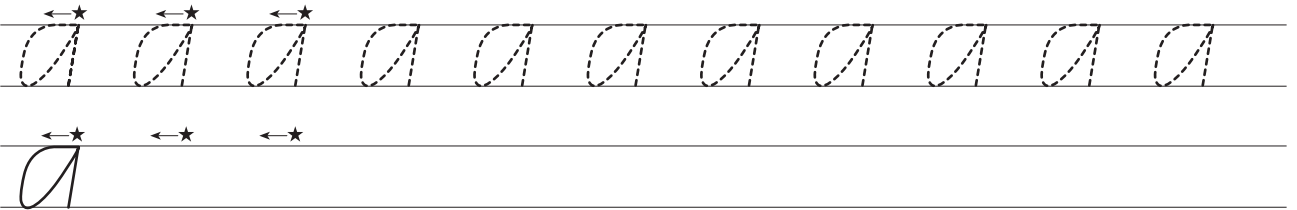

Trace over then **copy** the letter **A**.

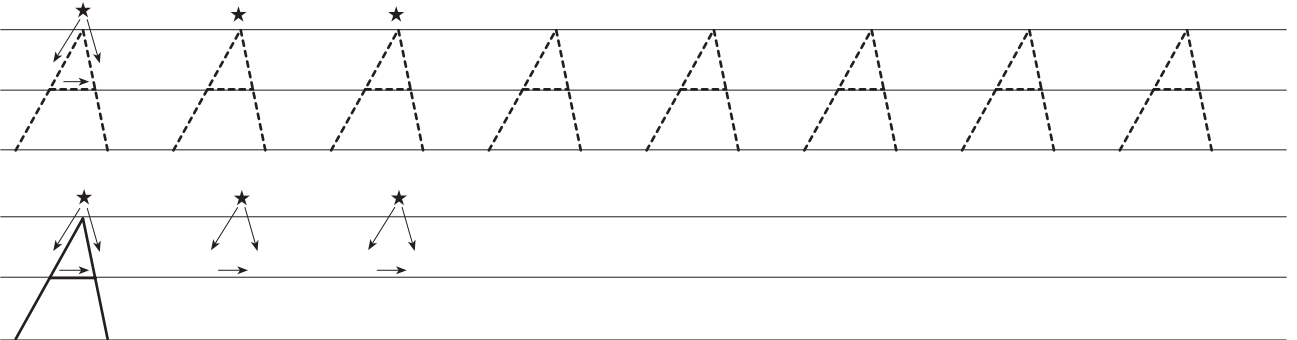

Trace over the letters **a** and **A** on the lines.

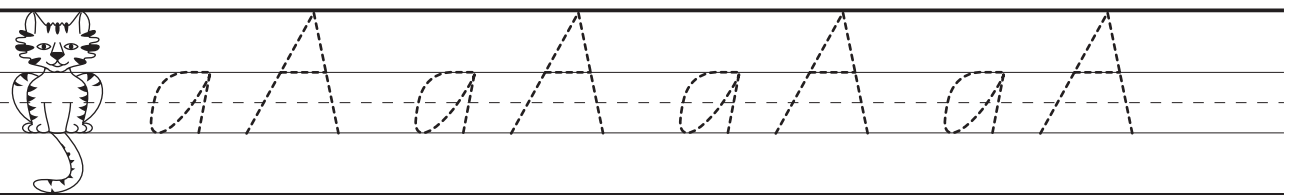

# Activities for a A

1 Find and circle the letter **a** in the alphabet.

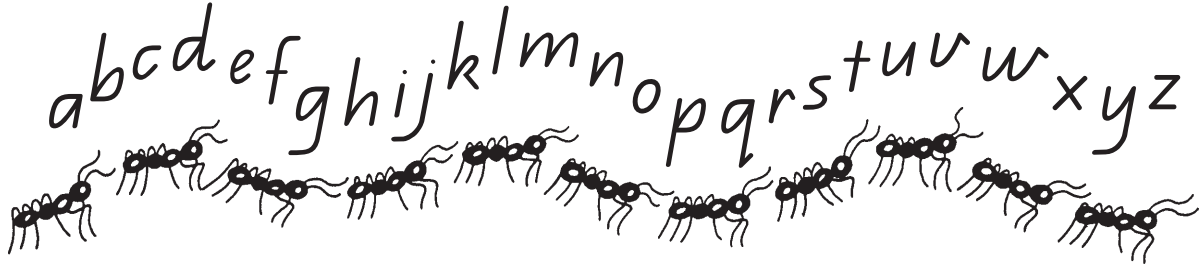

2 Circle the letters **a** and **A** in this line of letters.

a A d g H a o u a A b a c A B a

3 Colour the things that begin with the letter **a**.

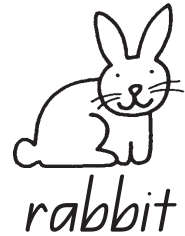
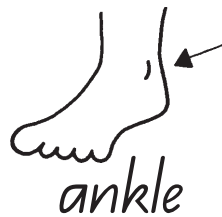
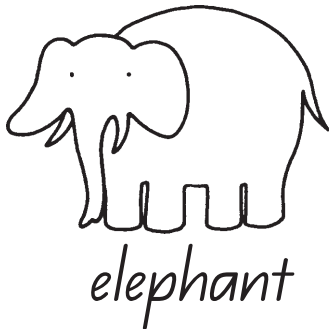
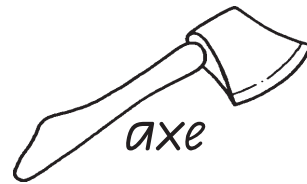

4 Circle each letter **a** in the words.

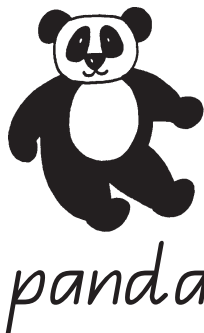

Word list for a A

a



A

ants on the apples

a... a... a...

ants

apple



# Model for b B



lower-case

capital

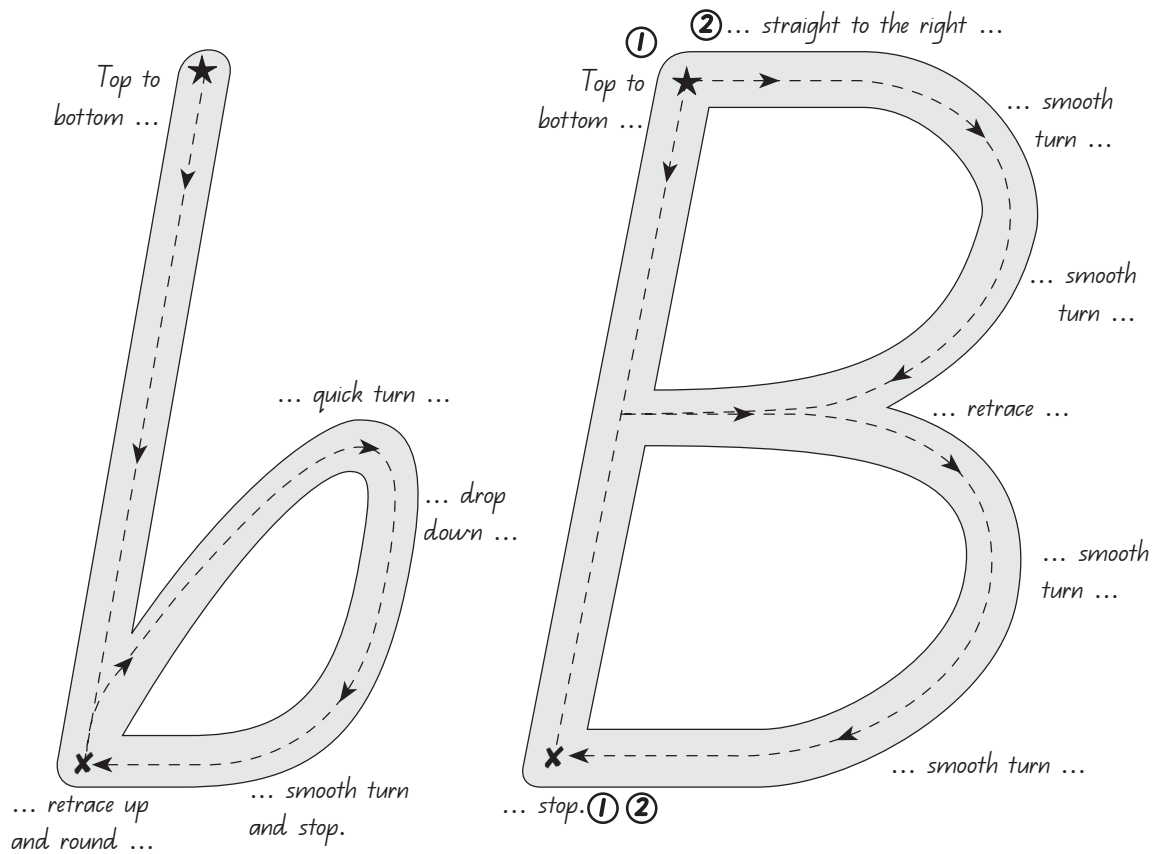

# Practice for b B

Trace over then copy the practice pattern.

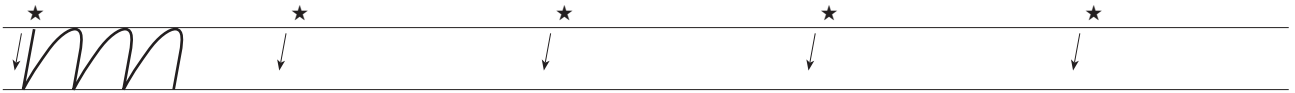
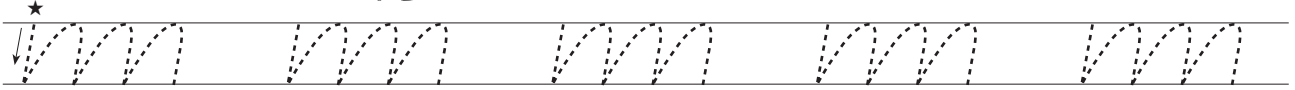

Trace over the letter b on the pattern.

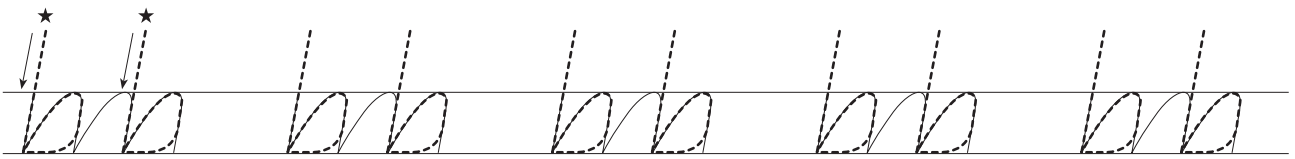

Trace over then copy the letter b.

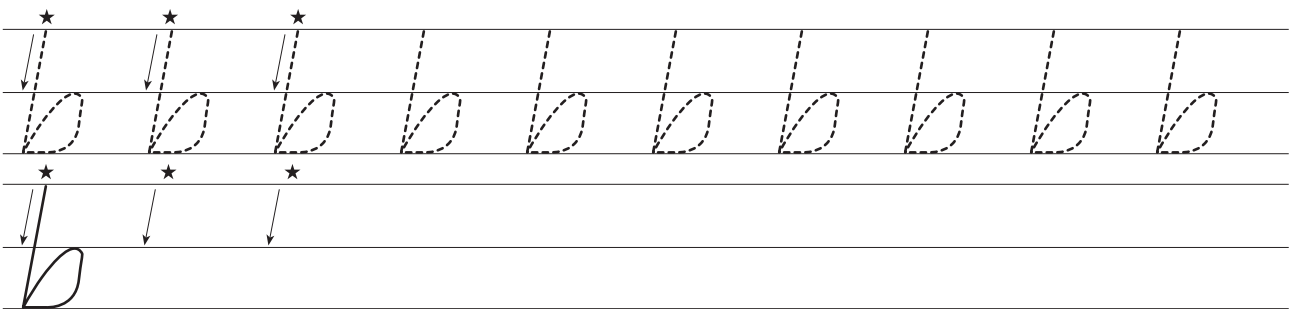

Trace over then copy the letter B.

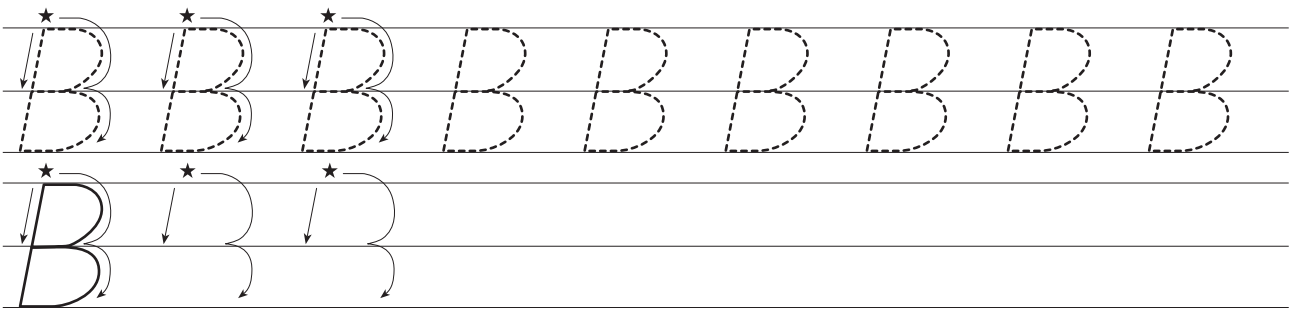

Trace over the letters b and B on the lines.

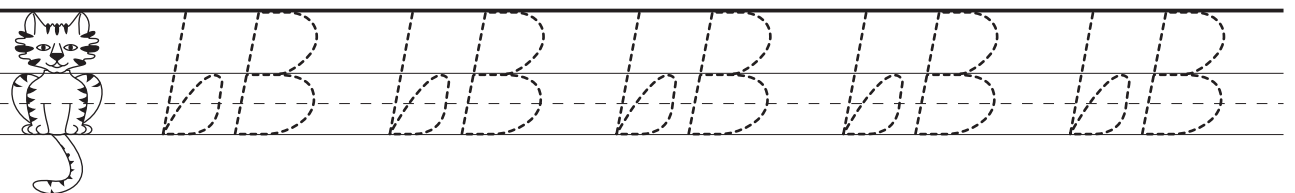

## Activities for b B

1 Find and **circle** the letter **b** in the alphabet.



2 **Circle** the letters **b** and **B** in this line of letters.

b a h D b d B H b n F B k m b

3 **Colour** the things that begin with the letter **b**.

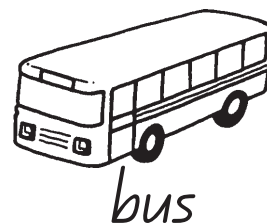
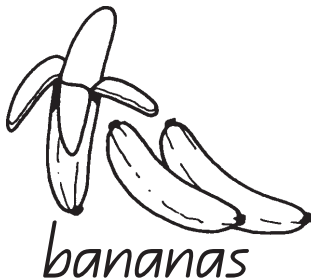

4 **Circle** each letter **b** in the words.

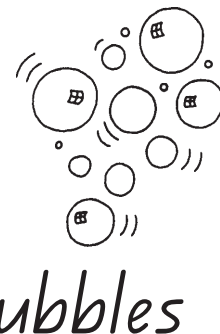
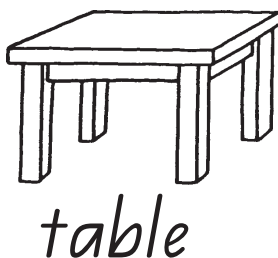
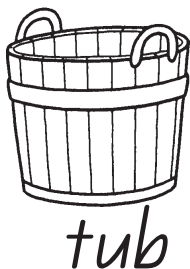

Word list for b B

b



B

*baboons with balloons*

*b... b... b...*

*balloon*

*bat*

Model for c C

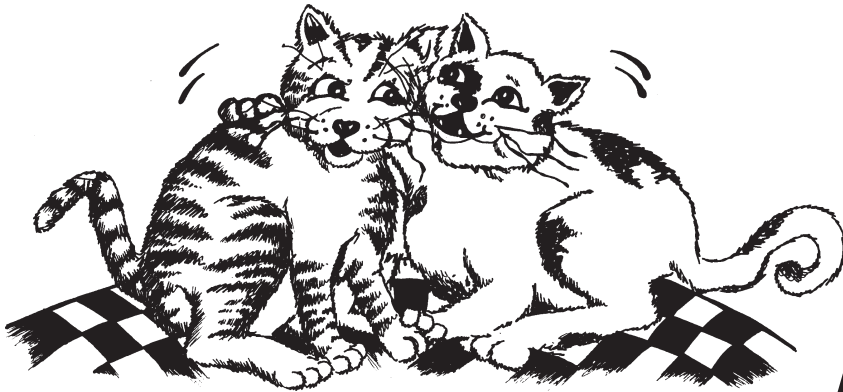

lower-case

capital

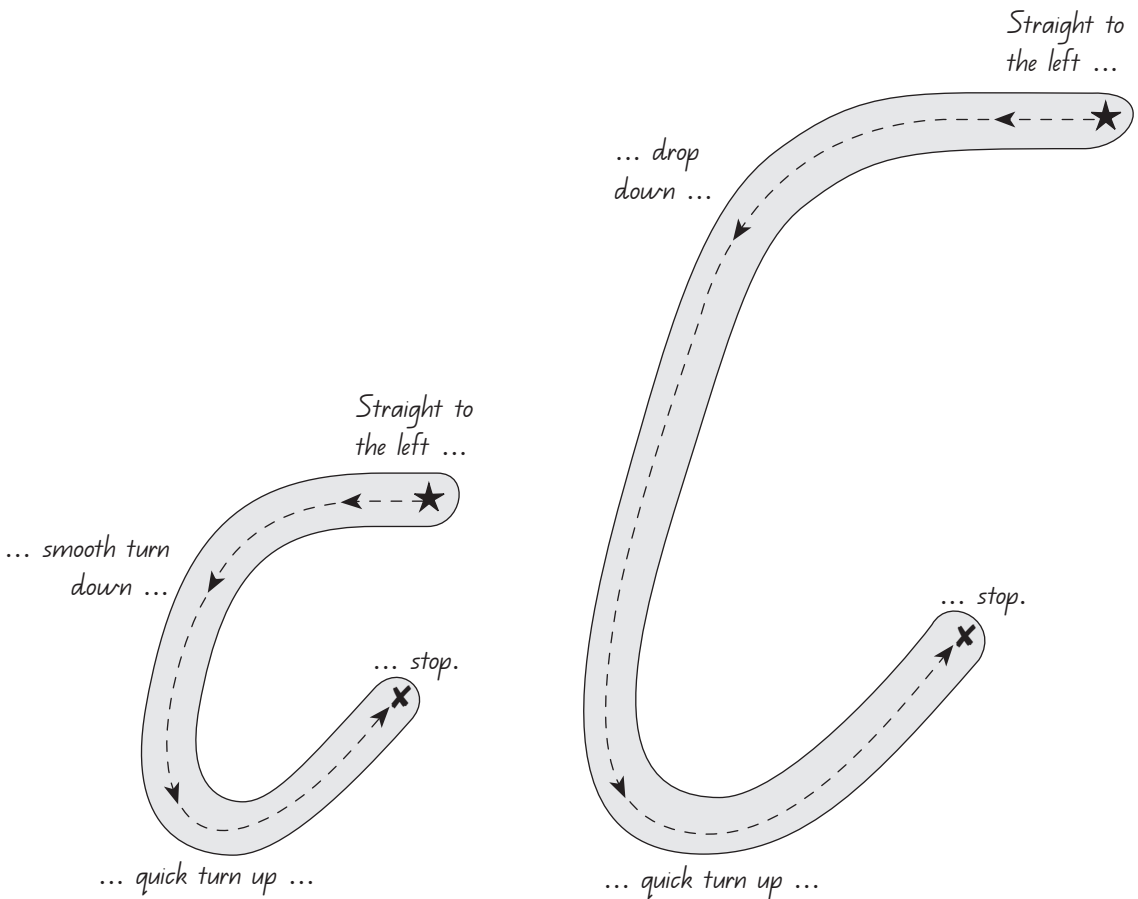

# Practice for c C

Trace over then copy the practice pattern.

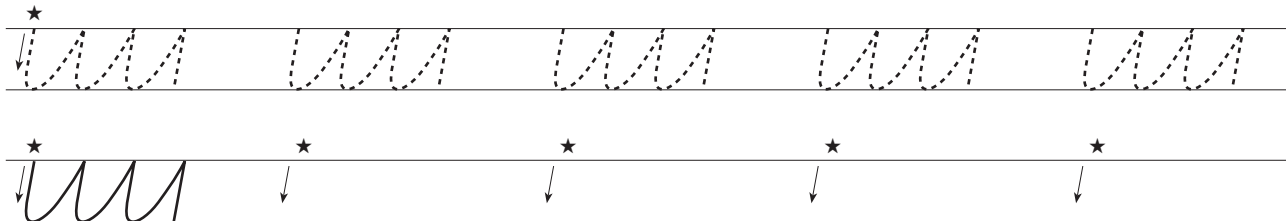

Trace over the letter c on the pattern.



Trace over then copy the letter c.

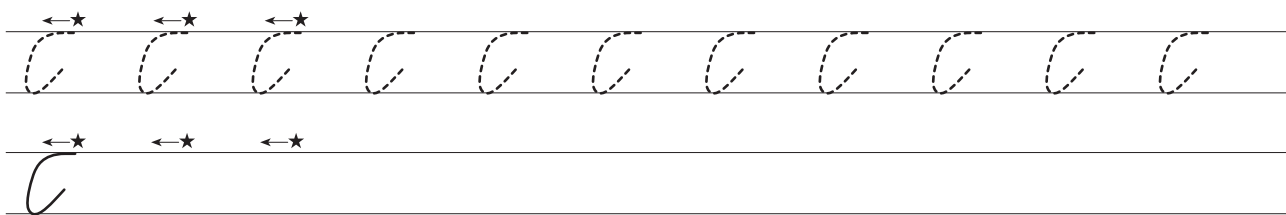

Trace over then copy the letter C.

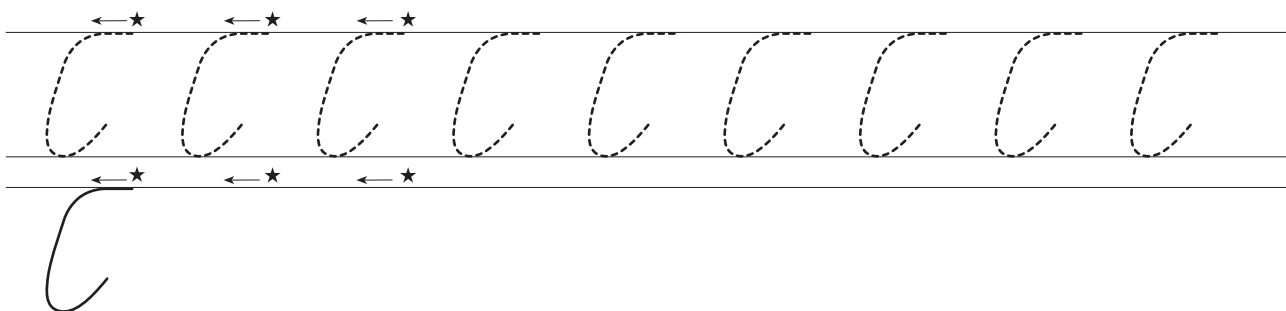

Trace over the letters c and C on the lines.

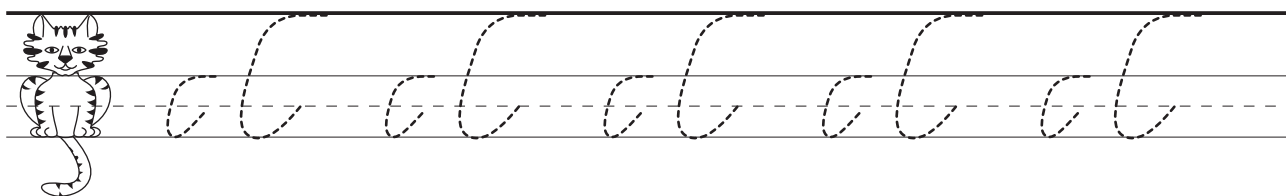

# Activities for c C

1 Find and circle the letter c in the alphabet.

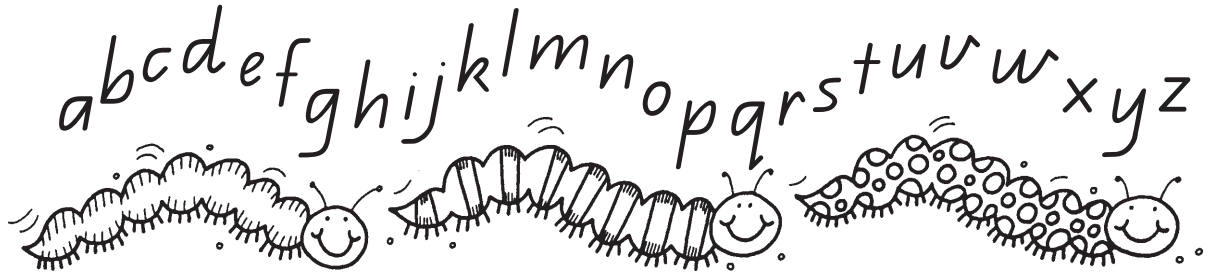

2 Circle the letters c and C in this line of letters.

c e c v m J s C c d e c o C a D C

3 Colour the things that begin with the letter c.

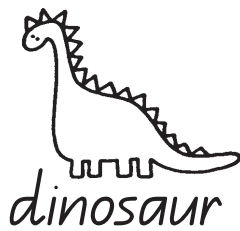

4 Circle each letter c in the words.



Word list for c C



cats are cuddling

c... c... c...

cat

cup



# Model for d D



lower-case

capital

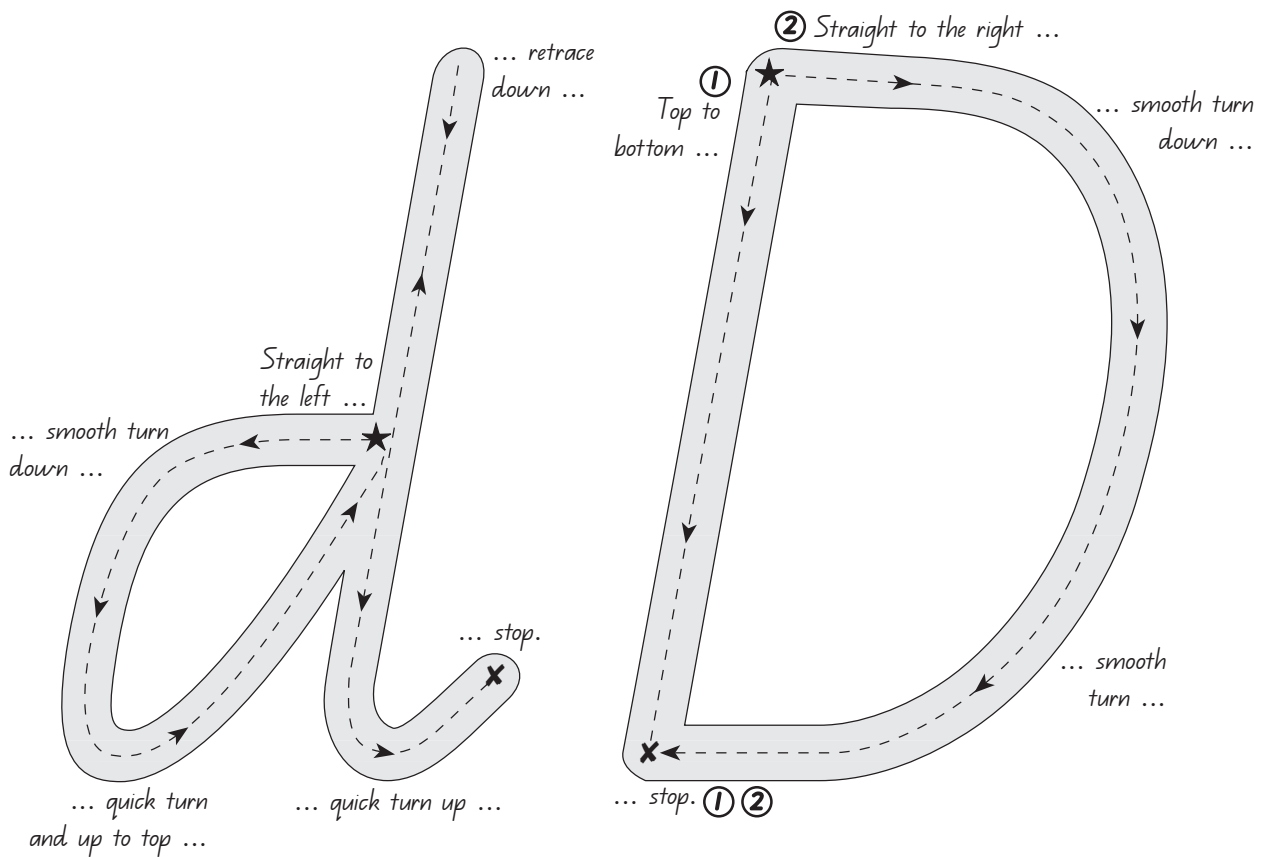

# Practice for d D

Trace over then **copy** the practice pattern.

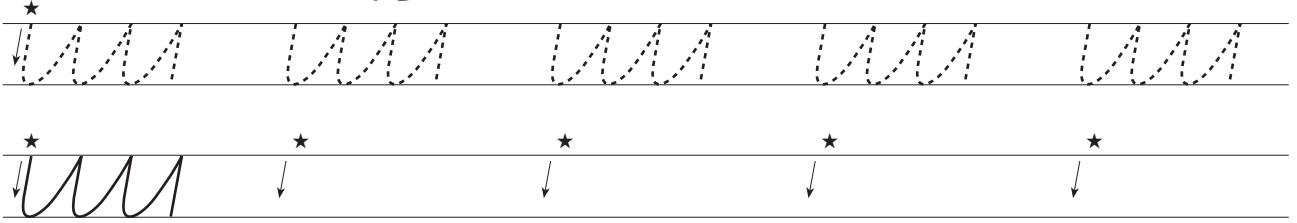

Trace over the letter **d** on the pattern.

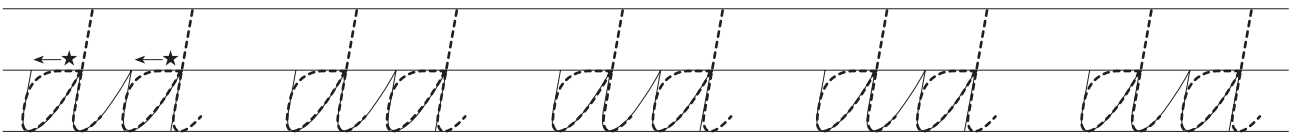

Trace over then **copy** the letter **d**.

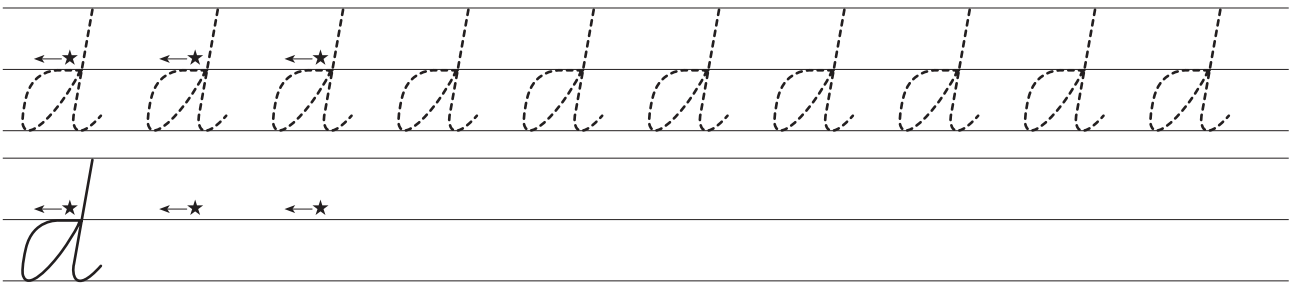

Trace over then **copy** the letter **D**.

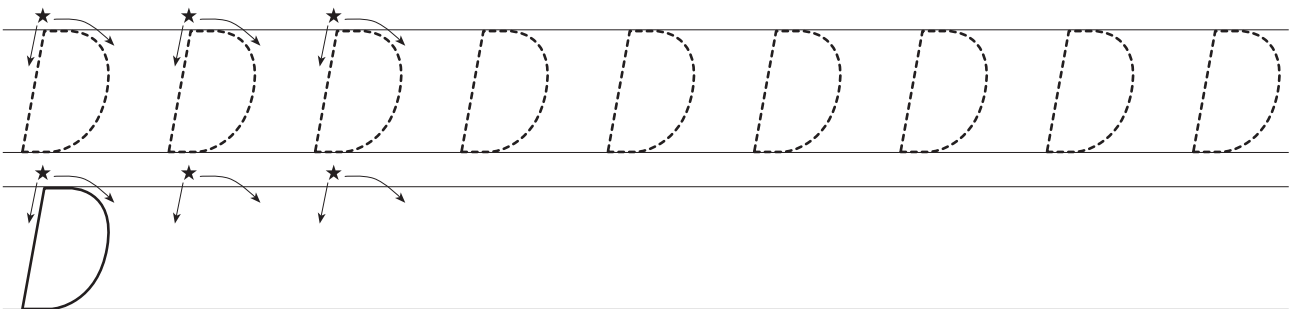

Trace over the letters **d** and **D** on the lines.

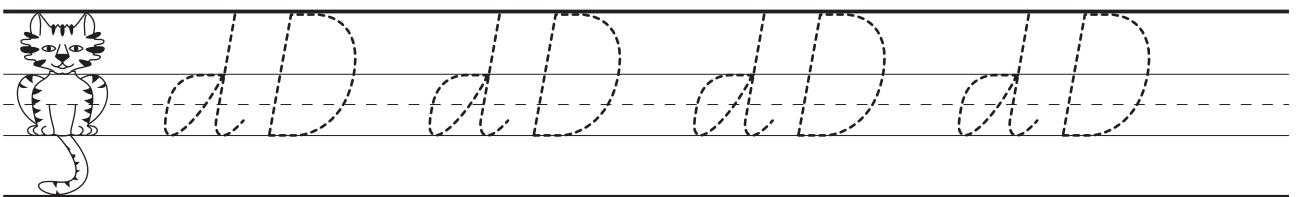

## Activities for d D

1 Find and circle the letter **d** in the alphabet.



2 Circle the letters **d** and **D** in this line of letters.

c D d a d b B g D f d C j d D p

3 Colour the things that begin with the letter **d**.

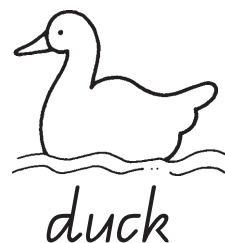
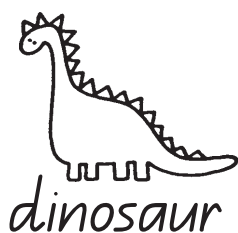
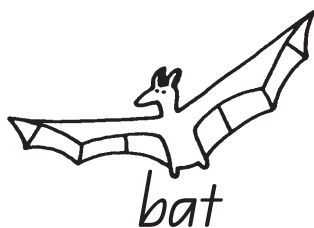
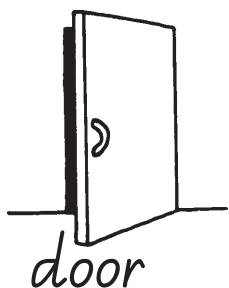

4 Circle each letter **d** in the words.

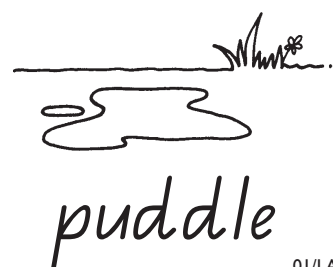
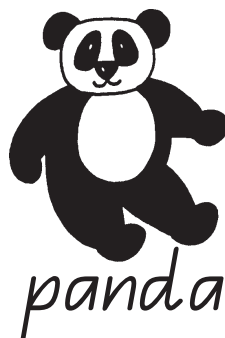

Word list for d D

d



D

dinosaurs are dancing

d... d... d...

dinosaur

dog

Model for e E

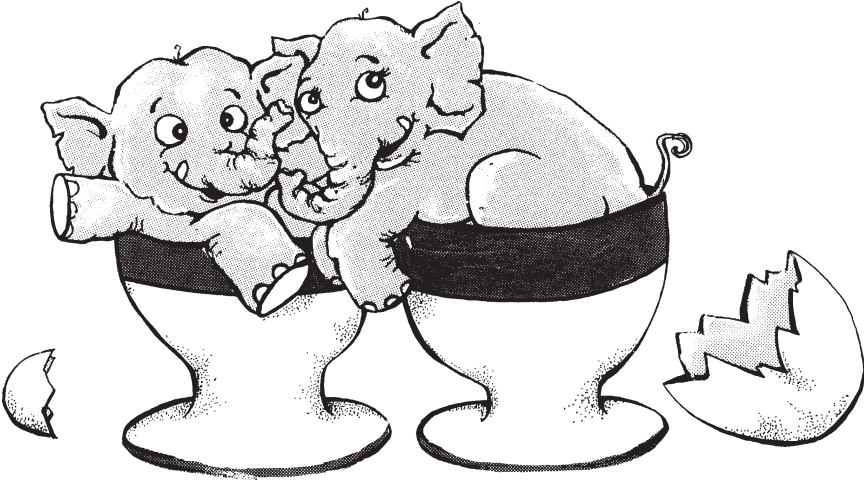

e

lower-case

E

capital

... smooth,  
quick turn  
down ...

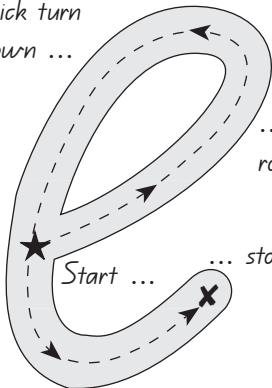

... up and  
round ...

... quick turn up ...

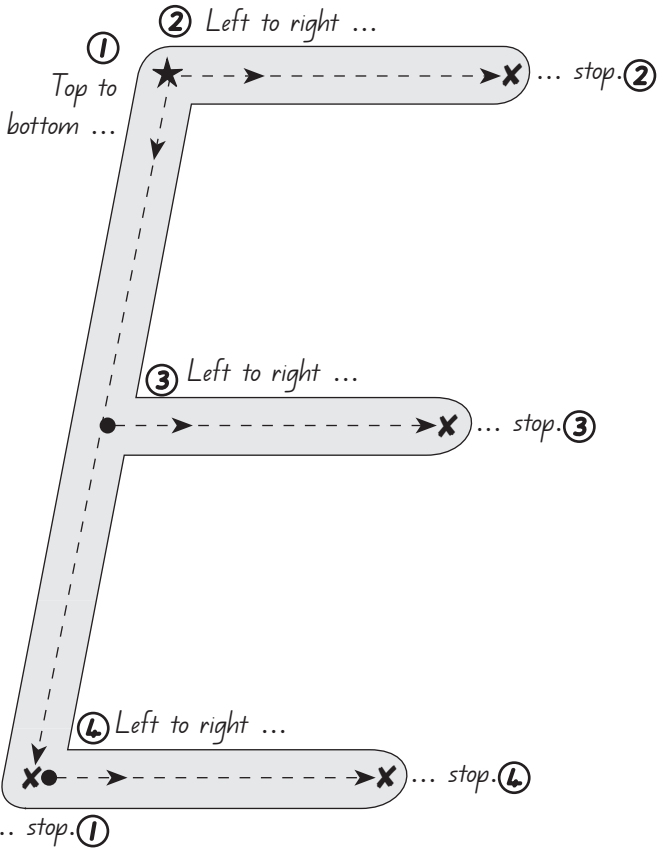

# Practice for e E

Trace over then copy the practice pattern.

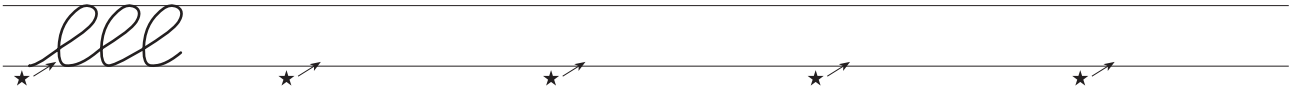
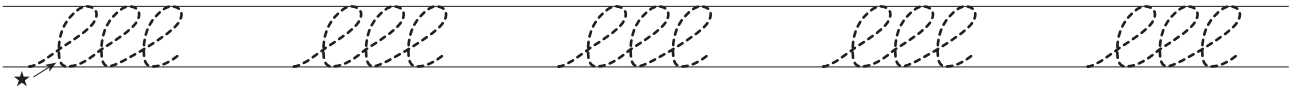

Trace over the letter e on the pattern.



Trace over then copy the letter e.



Trace over then copy the letter E.

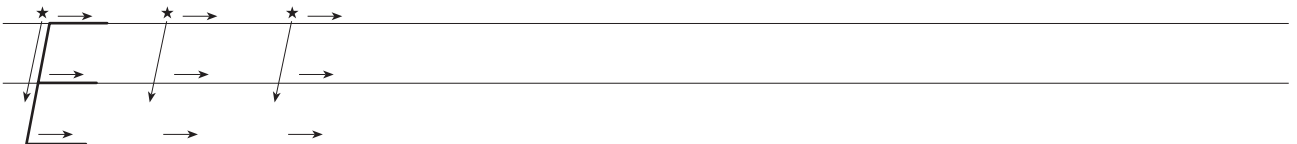
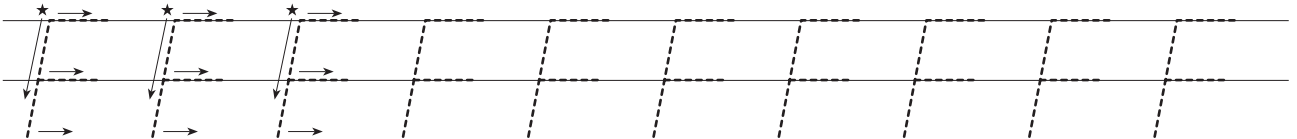

Trace over the letters e and E on the lines.

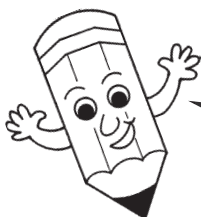
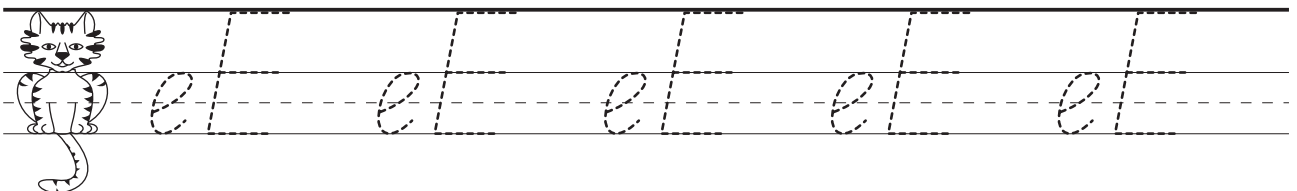

See how e starts just below the dotted line.

# Activities for e E

1 Find and circle the letter e in the alphabet.

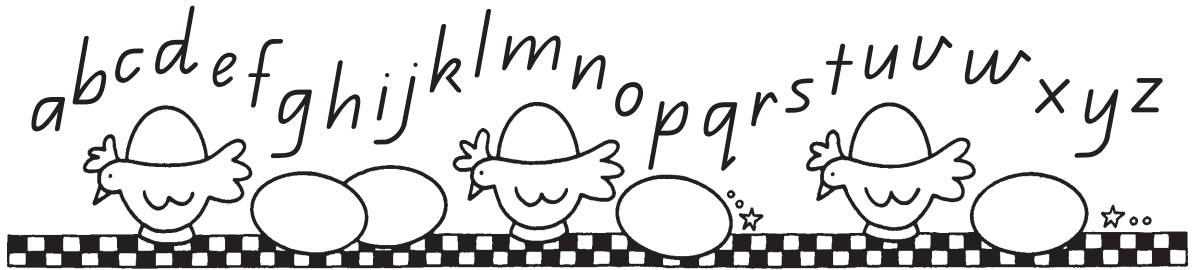

2 Circle the letters e and E in this line of letters.

c e u E m l e v i E e r n e B E K

3 Colour the things that begin with the letter e.

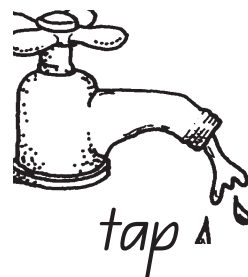
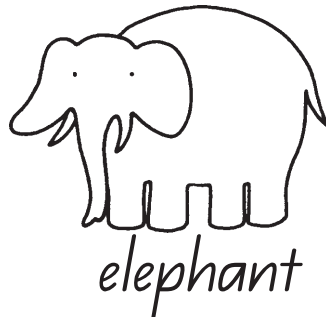
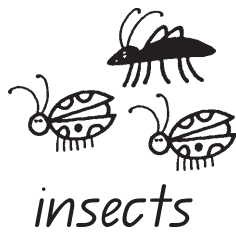
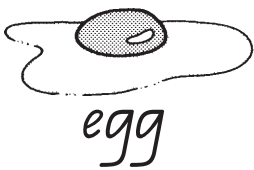

4 Circle each letter e in the words.

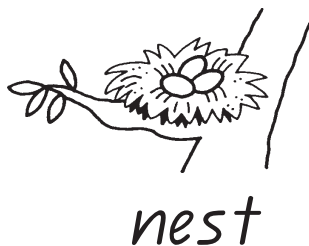

Word list for e E

e

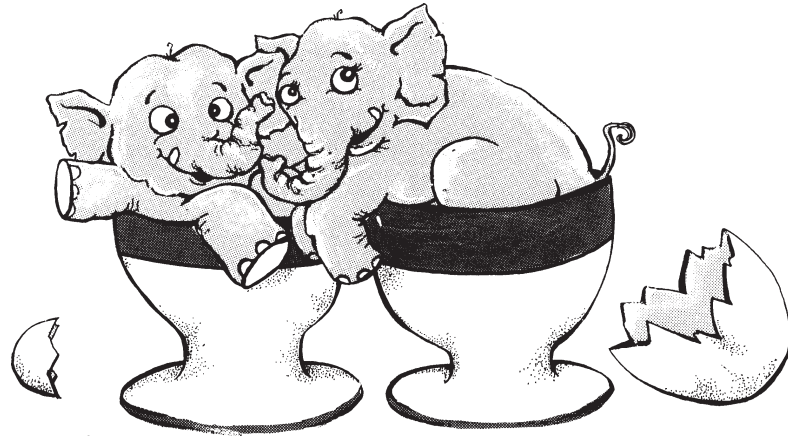

E

elephants in eggcups

e... e... e...

egg

elephant



Model for f F

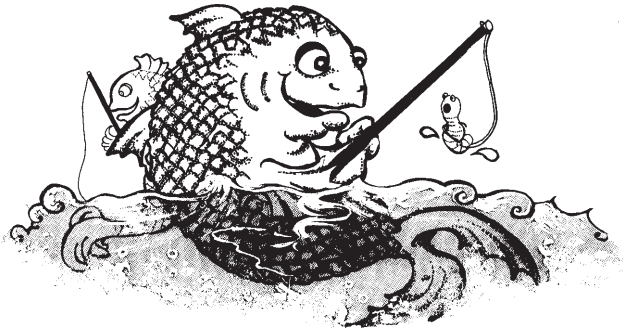

lower-case

capital

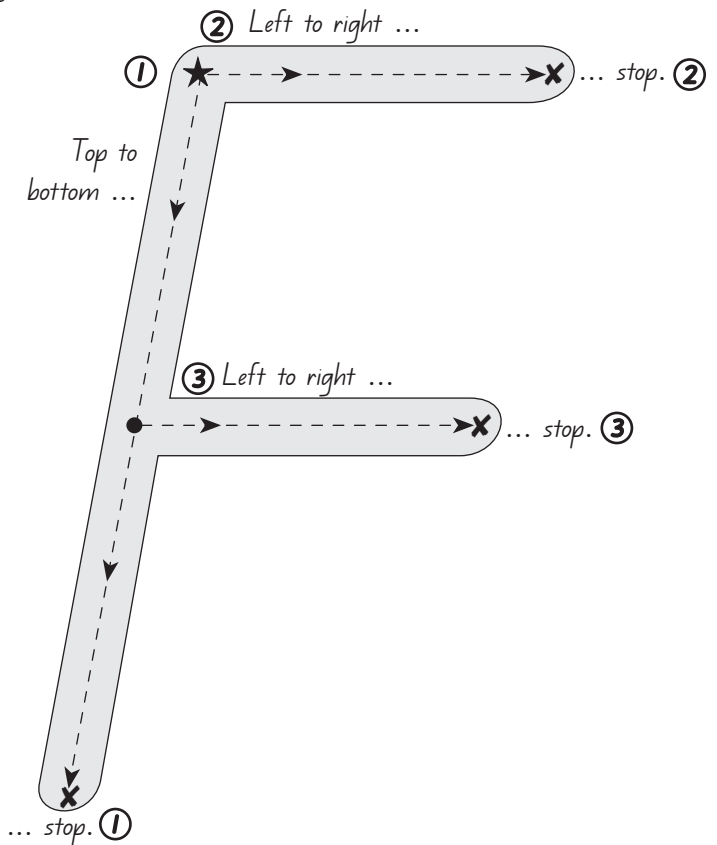
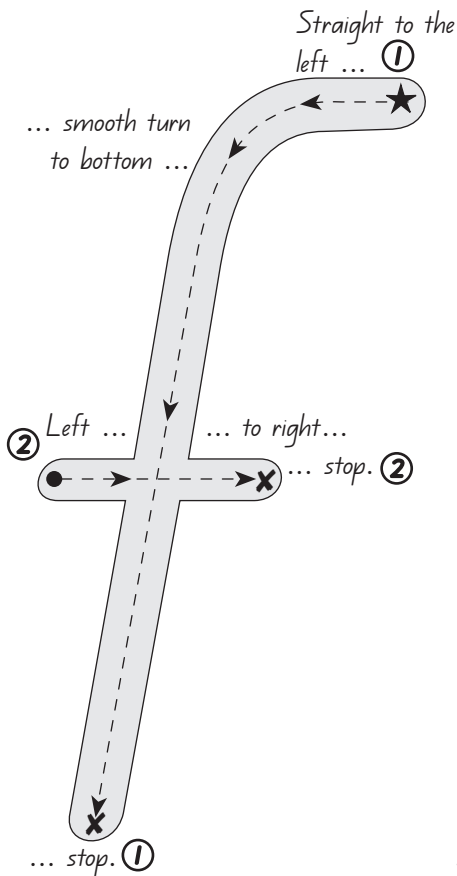

# Practice for f F

Trace over then copy the practice pattern.

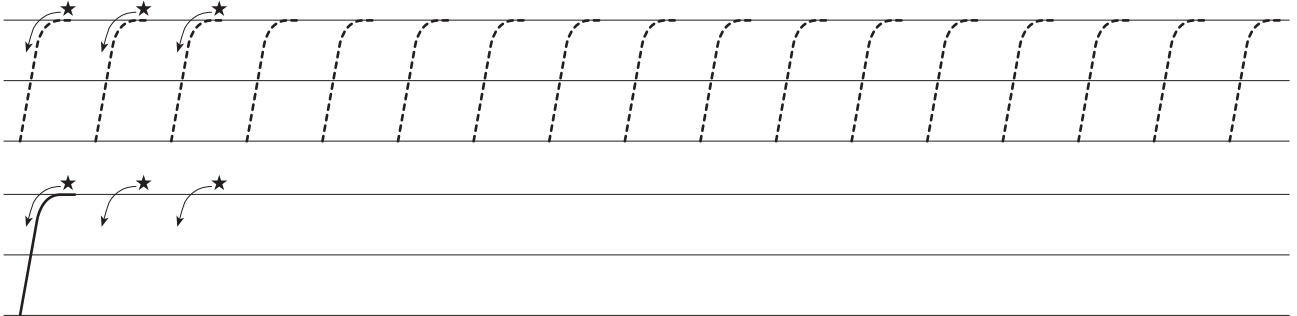

Trace over then copy the letter f.

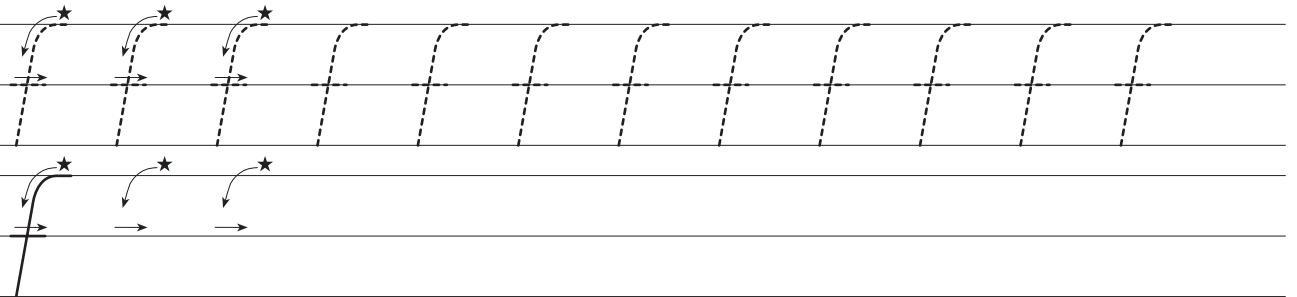

Trace over then copy the letter F.

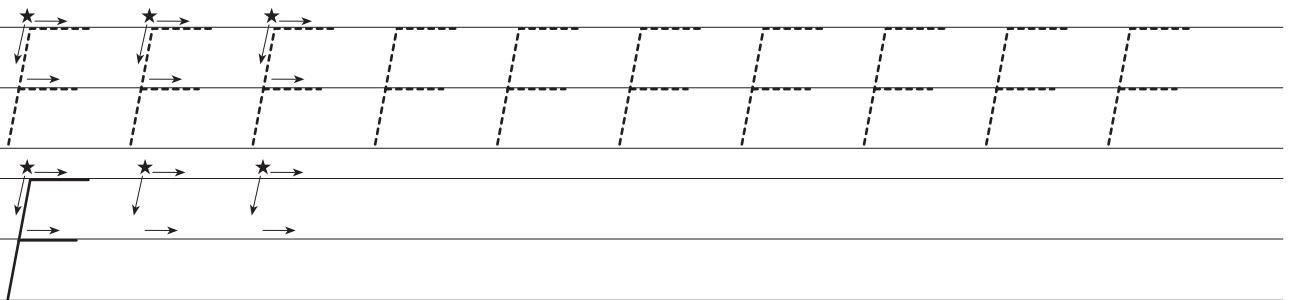

Trace over the letters f and F on the lines.

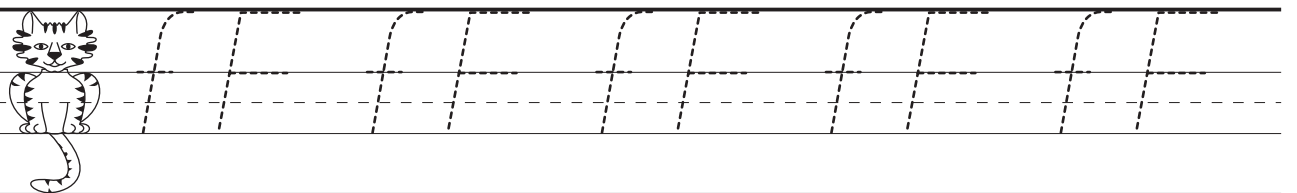

## Activities for f F

1 Find and **circle** the letter f in the alphabet.

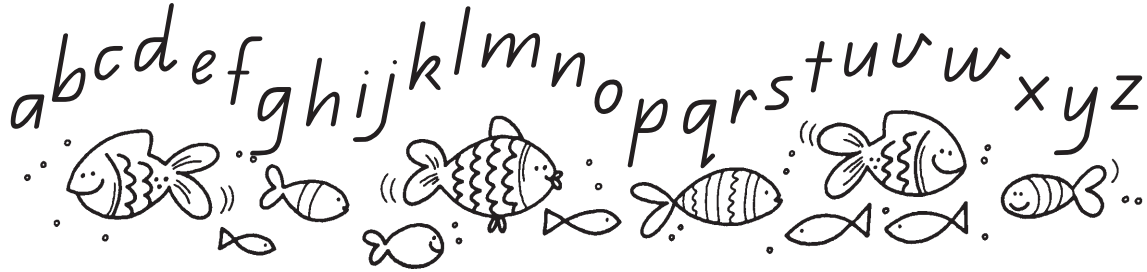

2 **Circle** the letters f and F in this line of letters.

f p s f h F P j f E + F f a k F

3 **Colour** the things that begin with the letter f.

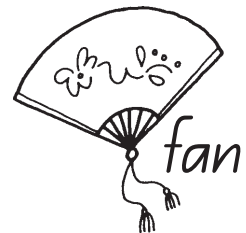
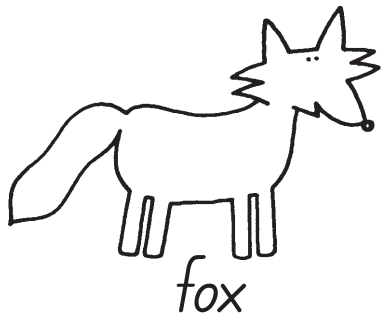
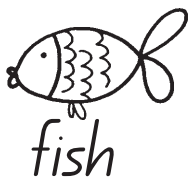

4 **Circle** each letter f in the words.

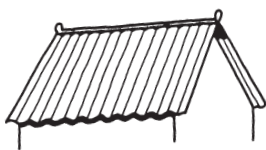

Word list for f F

f



F

fish are fishing

f... f... f...

fish

foot



# Model for g G



lower-case



capital



... smooth  
turn down ...

Straight to  
the left ...

... smooth turn  
down ...

Straight to  
the left ...

... down ...

... quick turn and  
up to the start ...

... quick turn and up ...

... stop.

... top to  
bottom ...

... smooth turn to the left ...

... stop.

# Practice for g G

Trace over then copy the practice pattern.

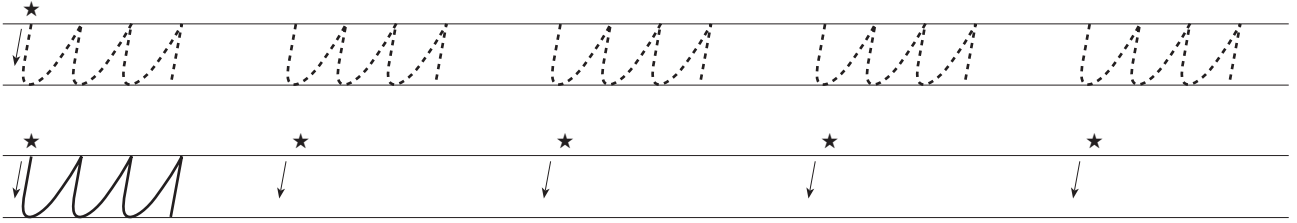

Trace over the letter g on the pattern.

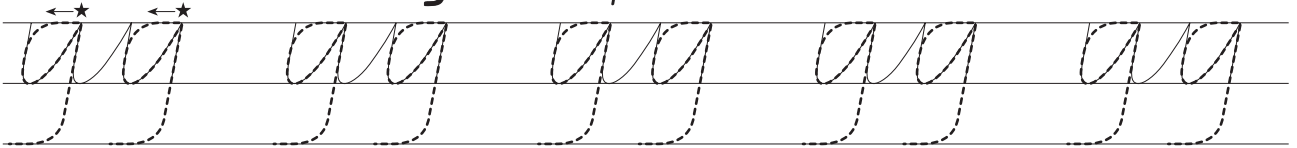

Trace over then copy the letter g.

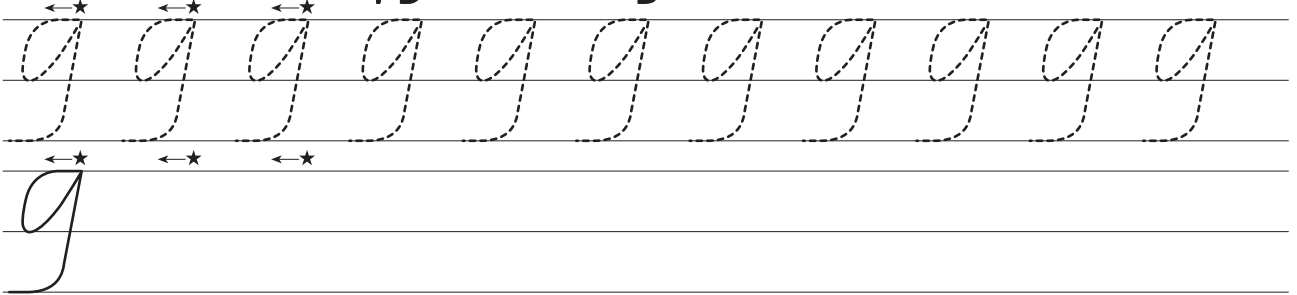

Trace over then copy the letter G.

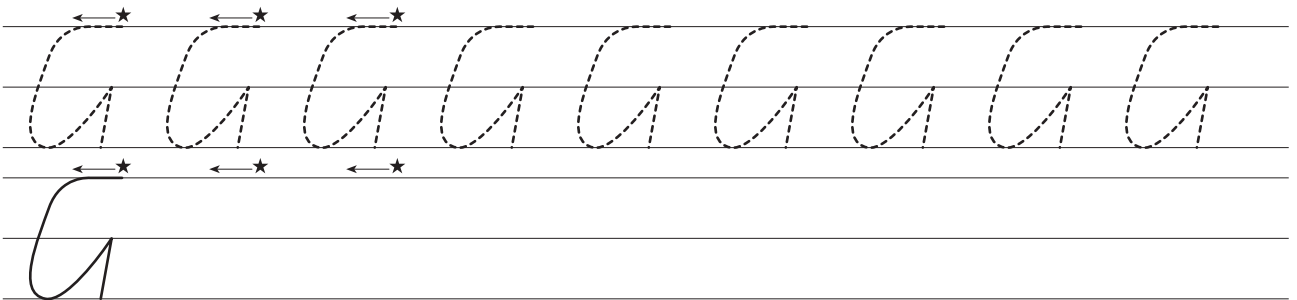

Trace over the letters g and G on the lines.

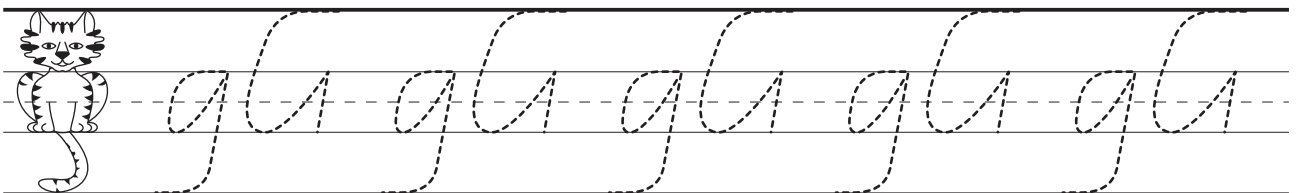

# Activities for g G

1 Find and circle the letter g in the alphabet.



2 Circle the letters g and G in this line of letters.

d g G a g h G d g l G D g c F a

3 Colour the things that begin with the letter g.

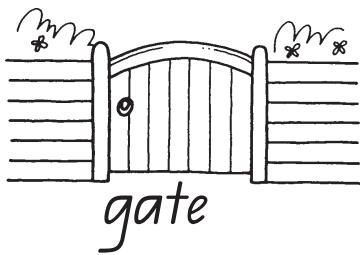

gate



dog

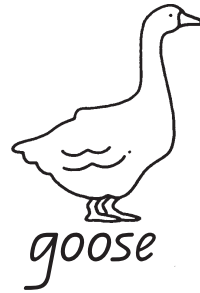

goose

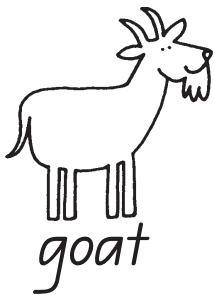

goat



bag



guitar

4 Circle each letter g in the words.



bag

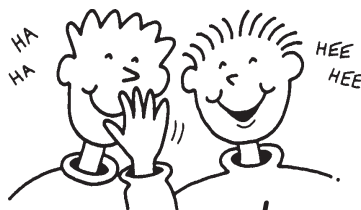

giggle

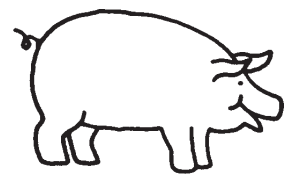

pig

Word list for g G

g

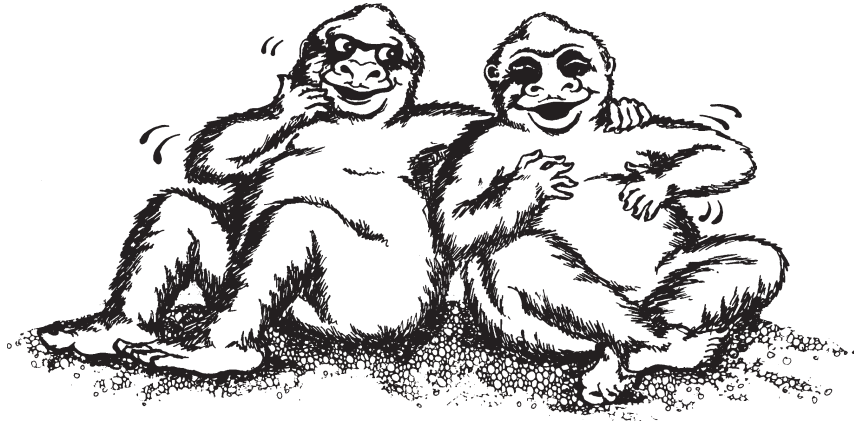

G

gorillas are giggling

g... g... g...

girl

goat



# Model for h H

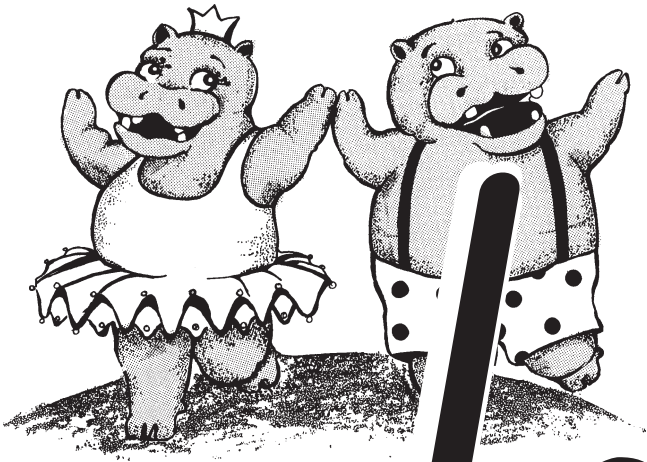

lower-case



capital

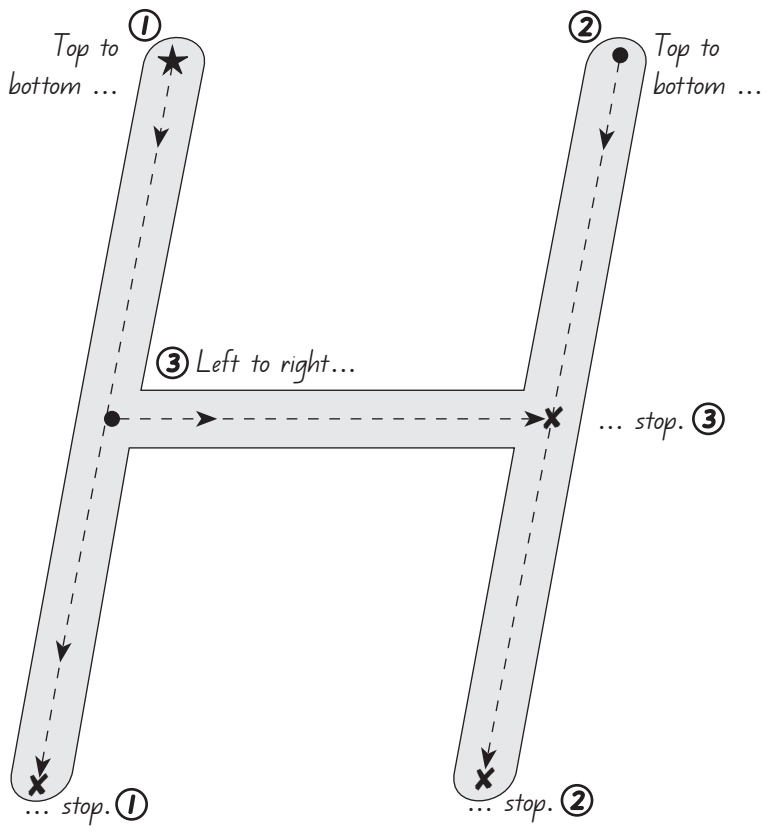
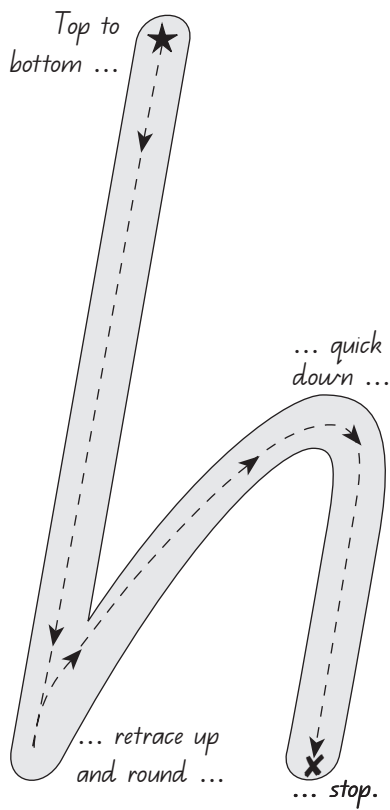

# Practice for h H

Trace over then copy the practice pattern.

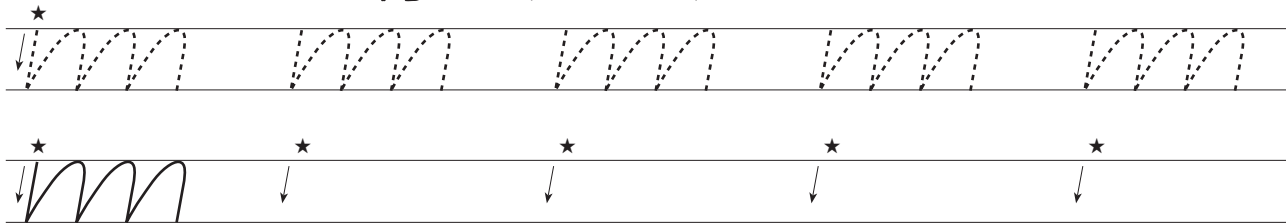

Trace over the letter h on the pattern.

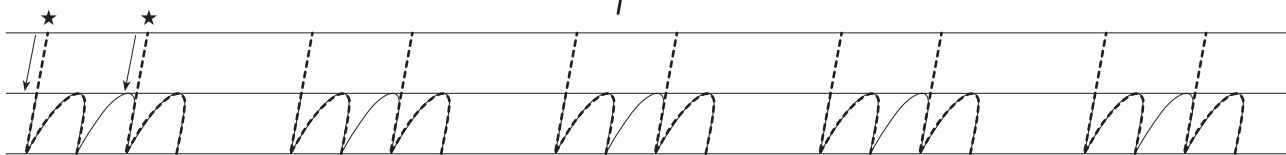

Trace over then copy the letter h.

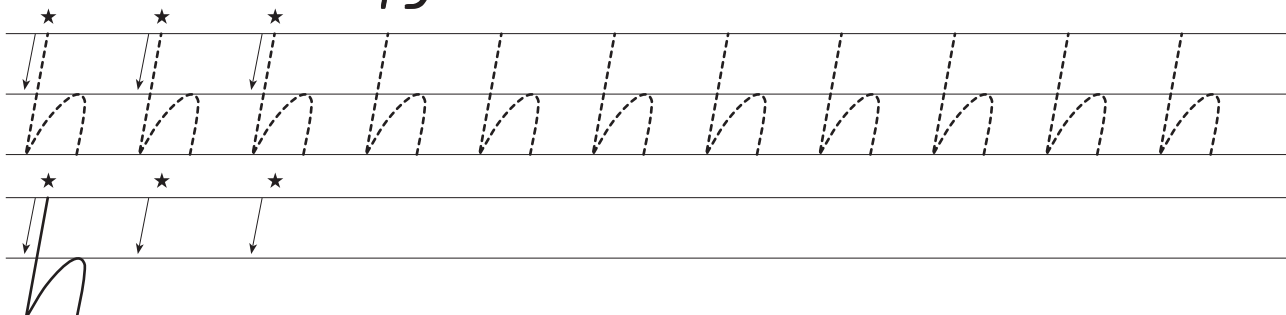

Trace over then copy the letter H.

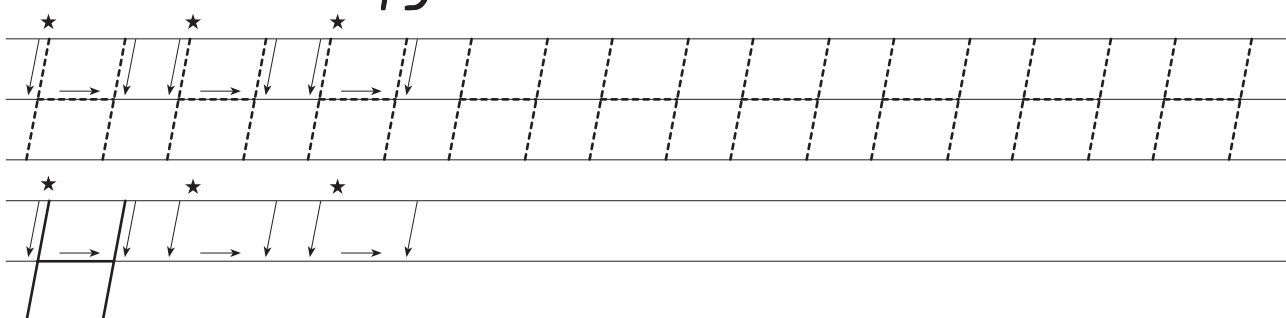

Trace over the letters h and H on the lines.

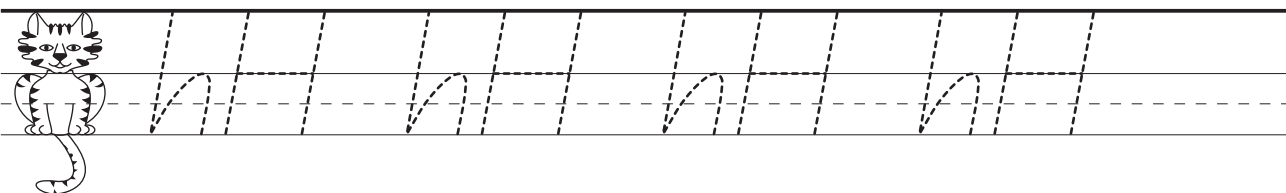

## Activities for h H

1 Find and **circle** the letter **h** in the alphabet.



2 **Circle** the letters **h** and **H** in this line of letters.

m a H b h H m h n r H A b h q

3 **Colour** the things that begin with the letter **h**.

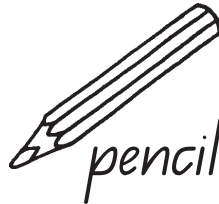
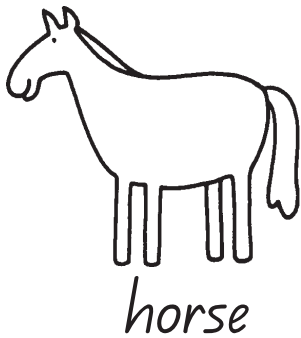
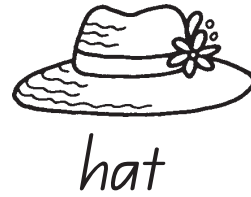

4 **Circle** each letter **h** and **H** in the words.

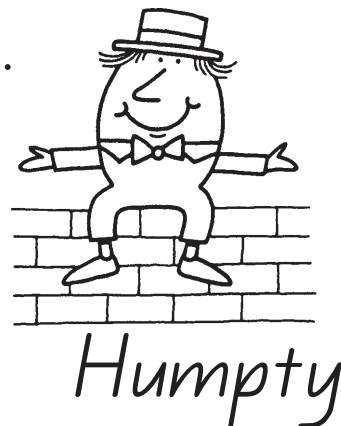
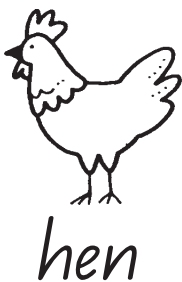

Word list for h H

h

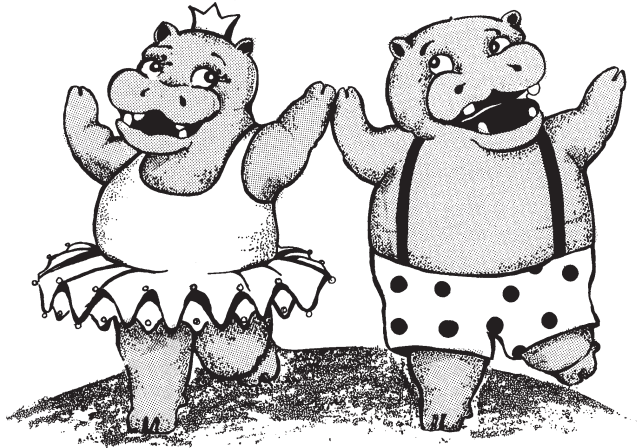

H

hippos are hopping  
h... h... h...

hand

hippopotamus

# Model for i I



lower-case

capital

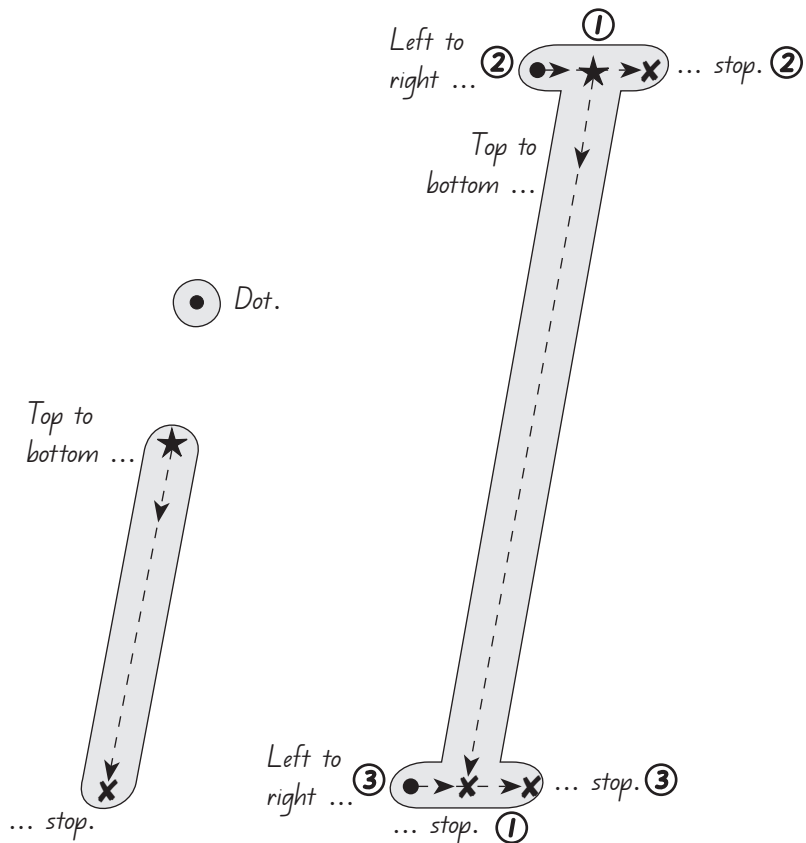

# Practice for i I

Trace over then copy the practice patterns.

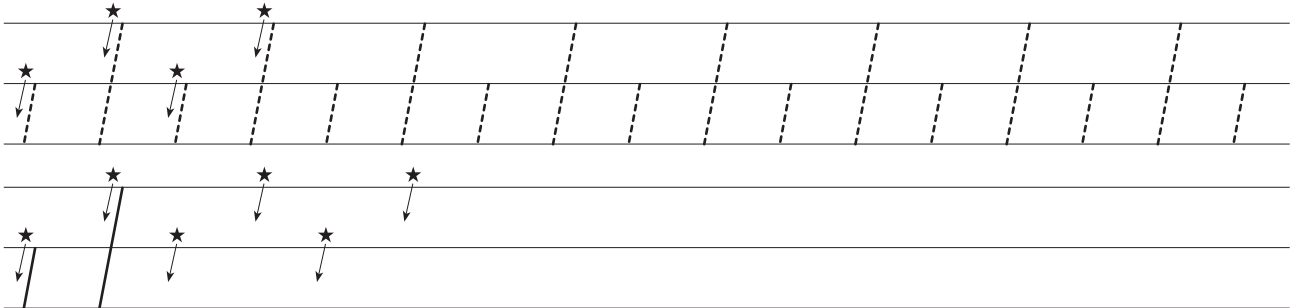

Trace over then copy the letter i.

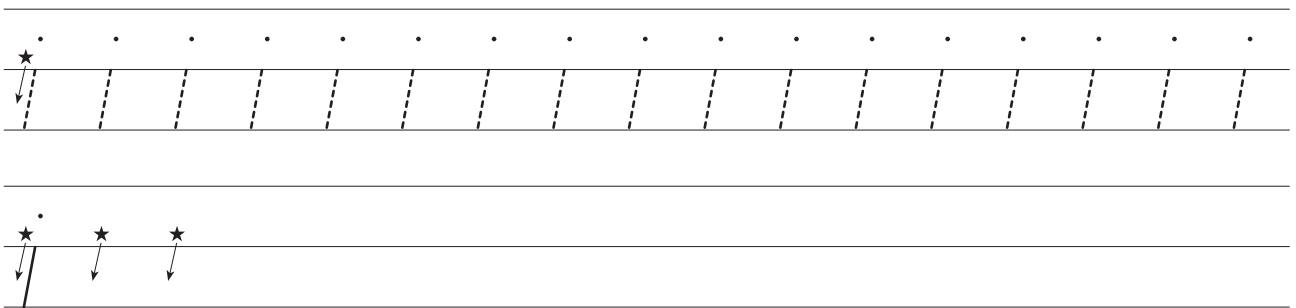

Trace over then copy the letter I.

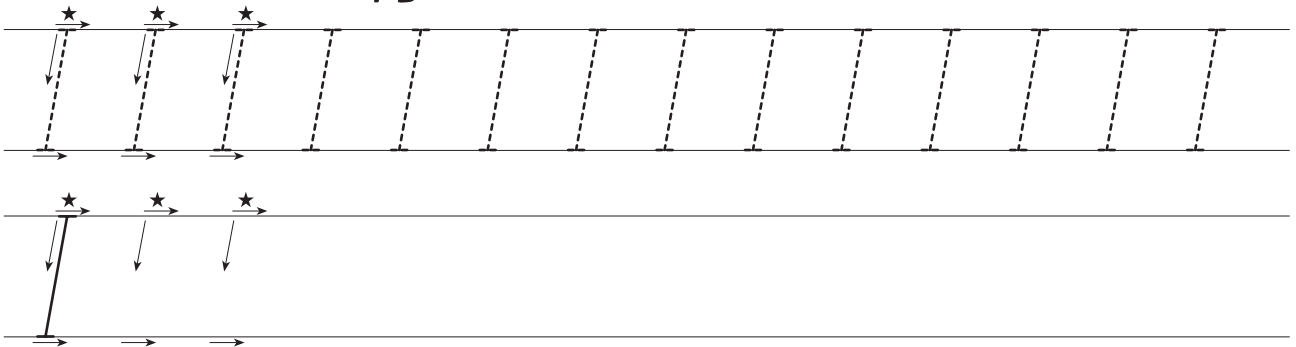

Trace over the letters i and I on the lines.

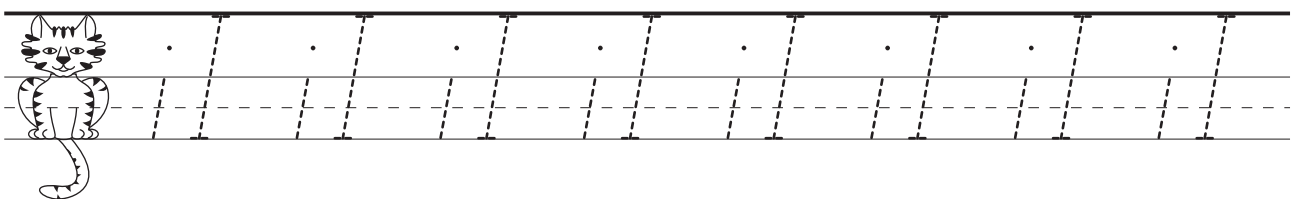

# Activities for i I

1 Find and circle the letter i in the alphabet.



2 Circle the letters i and I in this line of letters.

i b a t i I j k i l L I e i I z m i

3 Colour the things that begin with the letter i.

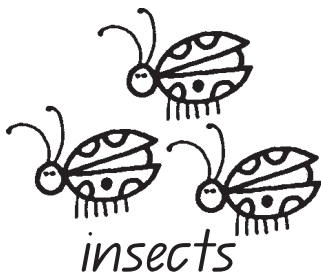

insects



igloo

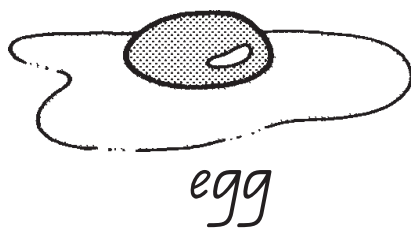

egg



ink

4 Circle each letter i in the words.

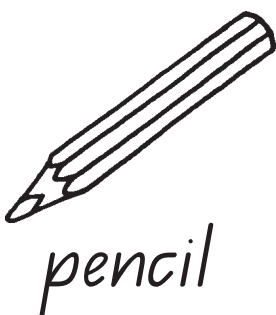

pencil



tin

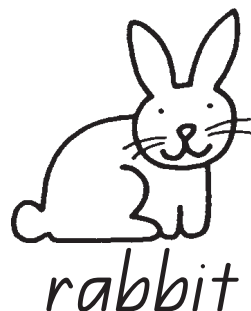

rabbit

Word list for i I



insects are itching

i... i... i...

insect

itch